



AMAZONE



Orientation Aid for the Start of the Season

Cobra x000-2TX

Table of Contents

1. General information
2. Requirements for operation of the implement
3. Assembly groups and functions
4. Hitching the implement and coupling the hydraulic system
5. Unfolding the implement
6. Basic positions of the implement
7. Implement in field operation – according to the type of hitch and drawbar
8. Adjust the working depth
9. Driving with and without roller
10. Adjusting the levelling unit
11. Using the crushboard (additional equipment)
12. Using the cutting roller (additional equipment)
13. Using the traction assistance (additional equipment)
14. Preparing for road transport
15. Preparing for road transport – with crushboard or cutting roller

1. General information

- Use of this document requires that the **operating manual** for the implement has been read and understood. The corresponding document is shown on the right side.
- For this reason, it is **necessary** to refer to the operating manual for additional information. The **operating manual** must **always be available** when performing the orientation aid for the start of the season with the Cobra x000-2TX.
- The **Orientation Aid for the Start of the Season - Cobra x000-2TX** document serves as a guideline for the user to check the implement for the new season and to put it back into operation. This document is based on the current implement generation and is also only valid for this version.

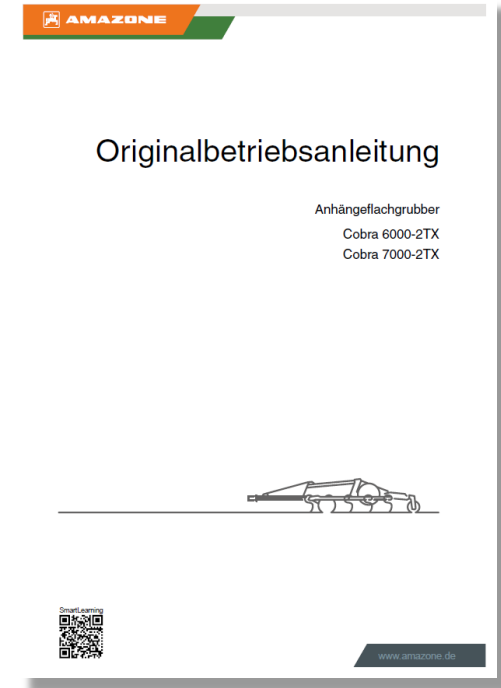

MG7478

2. Requirements for operating the implement

Requirements for the hitches

- Lower link hitch – Cat. 3/Cat. 4N/Cat. K700
- Ball hitch coupling
- Drawbar eye

PLEASE NOTE: see spare parts portal for the product range

Requirements for the tractor pulling power

- Starting at 40 HP/m working width

Requirements for the tractor hydraulic system

- Depending on the equipment, 2 – 4 double-acting control units
- Oil capacity of min. 150 bar at 15 l/min
- Maximum system pressure 210 bar

Requirements for ballasting the tractor

- The permissible total weight of the tractor **MUST** be greater than:
 - Tractor empty weight + ballast weight + drawbar load of the trailed implement
- The tractor front axle must always be loaded with at least 20 % of the tractor empty weight.
- [3] Vehicle ID number
- [4] Permissible technical total weight
- [A0] Permissible technical drawbar load of the implement
- [A1] Permissible technical axle load of the implement
- [B4] Permissible technical trailer load for a vehicle with pneumatic service brake

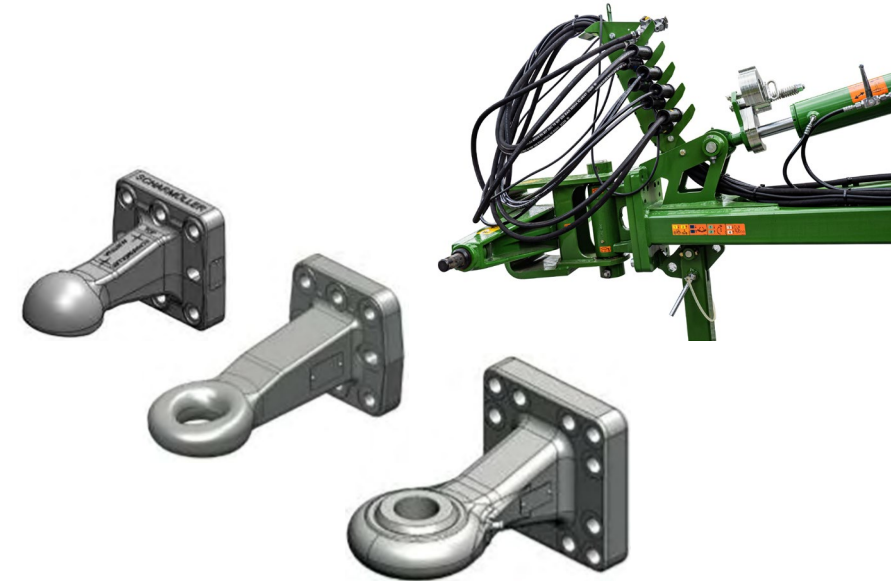

AMAZONEN-WERKE H. DREYER SE & Co. KG						
	1				2	
		3				4 kg
		T-1	T-2	T-3	A-0:	kg
B-2		-	-	-	A-1:	kg
B-4	5		-	-	A-2:	kg

3. Assembly groups and functions

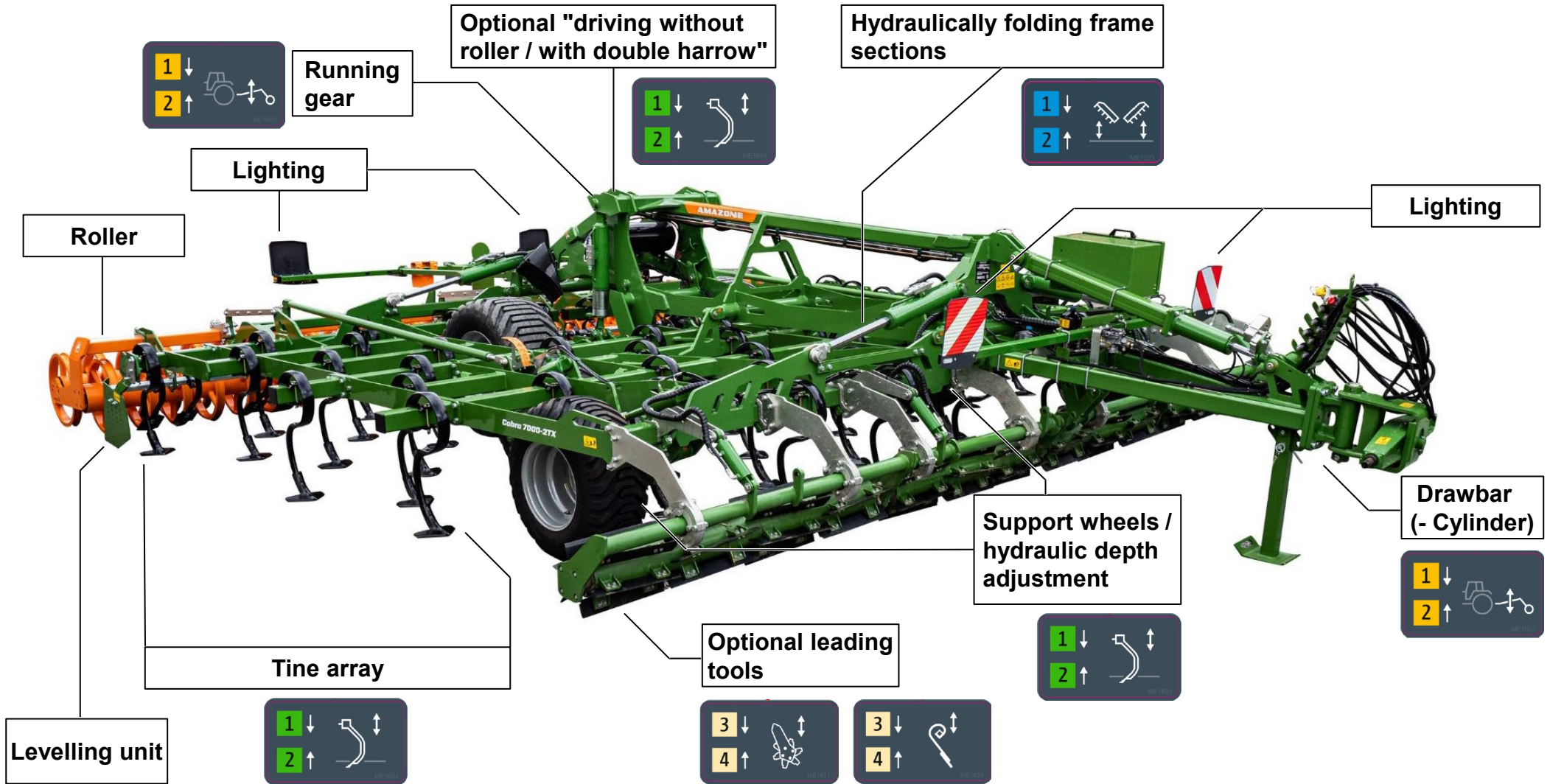

4. Hitching the implement and coupling the hydraulic system

1. Hitch the implement.
2. Connect the hydraulic plugs to the connections of the tractor hydraulic system.
3. Open the drawbar cylinder ball valve (1) – when equipped with hydraulic drawbar.
4. Lift the implement [2 ↑] and fold in the jack, release the parking brake beforehand.
5. Swivel the spacer elements from the piston rod – when equipped with hydraulic drawbar.

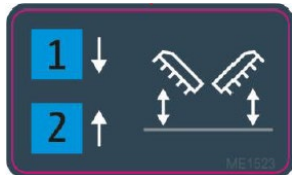
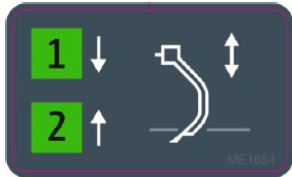
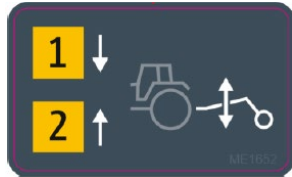

TIP:

- Select the control units according to the frequency of use during operation.
Suggestion >>> yellow / beige / green / blue (see pictograms at the edge of the page)



- Couple the **hydraulic plugs 1 and 3** on the side of the tractor control unit (–), which can be directly switched to float position after actuation.



5. Unfolding the implement

1. Lift the implement completely with [2 ↑]

PLEASE NOTE:

Only unfold in a lifted state – otherwise there is a risk of damage to the working tools.

For implements with a rigid drawbar, also lift with the lower links to ensure sufficient ground clearance.

2. Unfold the side sections completely with [1 ↓].

PLEASE NOTE:

When the lifted implement is unfolded, the side sections are slightly overstretched!

3. After unfolding [1 ↓], switch directly to float position.

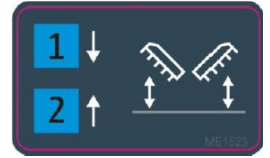
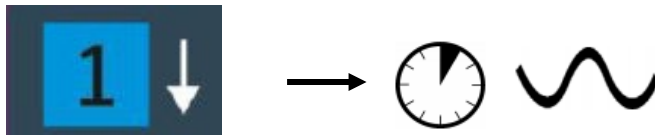

6. Basic positions of the implement

Headlands position

1. Implement completely unfolded – blue switched to float position



2. Lift the implement completely – yellow switched to "0" position



'Working position'

1. Implement completely unfolded – blue switched to float position

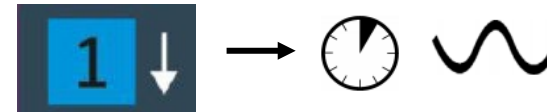

2. Lower the implement completely – switch yellow to float position

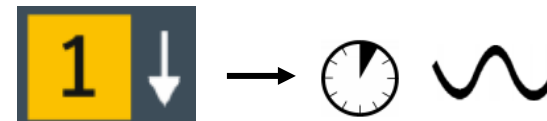

7. Implement in field operation – according to the type of hitch and drawbar

Implement with rigid drawbar and lower link hitch

1. Switch the lower link of the rear hydraulic system to float position
2. Actuate the "yellow 1" control circuit until the running gear hydraulic cylinders (1) are completely retracted and are resting on the stop plate (2)
3. Switch the "yellow 1" control circuit to float position

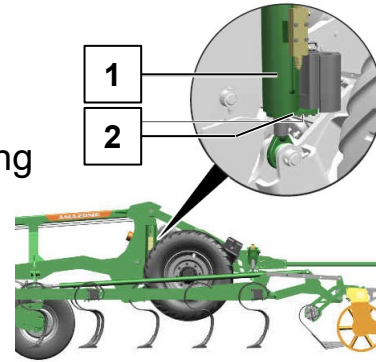

Implement with hydraulically adjustable drawbar

1. Stop tap on the drawbar is open (1)
2. Swivel all of the spacer elements away from the piston rod (2)
3. Actuate the "yellow 1" control circuit until the running gear hydraulic cylinders (3) are completely retracted and are resting on the stop plate (4)
4. Switch the "yellow 1" control circuit to float position

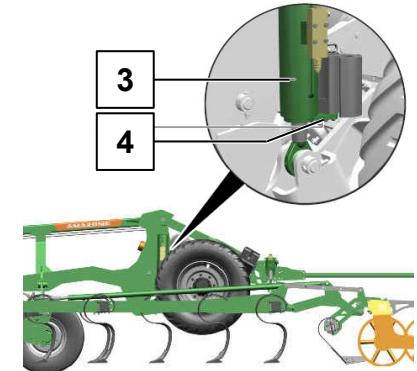
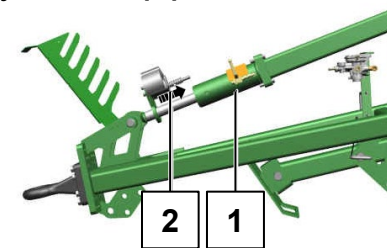

i NOTE

- When operating the implement with **drawbar eye and ball hitch coupling >> Fixed hitching height**
- When operating the implement with **lower link cross member**
 - >> Adjust the hitching height with the rear hydraulic system and maintain it
 - >> Adjust the hitching height of the lower links such that the drawbar is horizontal during operation

8. Adjusting the working depth

Hydraulic working depth adjustment

- The working depth can be adjusted during field operation with the green hydraulic function .

 Deeper

 Shallower

- The working depth is adjusted by moving the depth adjustment cylinders on the support wheels. (1)
- If the implement is equipped with the **optional function "working without roller/working width double harrow"**, the working depth is adjusted synchronously also on the **double running gear cylinder**. (2)
- Read the working depth from the scale as a reference value. (3)

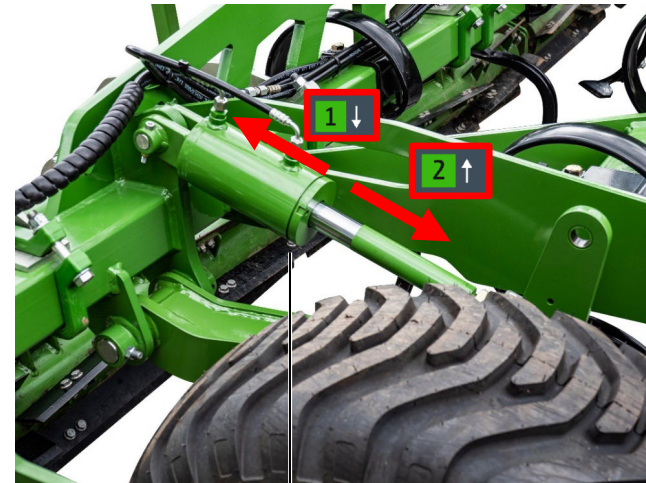
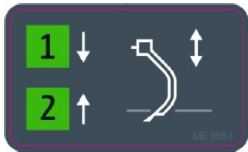

1

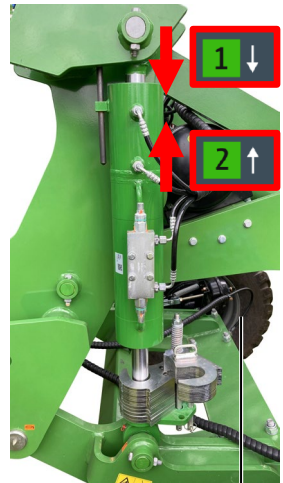

2



3

i NOTE

Calibrate the depth adjustment circuit several times daily. Set the minimum working depth /  for approx. 15 s.

Check the work pattern:
 Move the implement into **working position**.
 Drive at **working speed (10-16 km/h)**.
 Expose the tillage horizon / check the work pattern.

9. Driving with roller

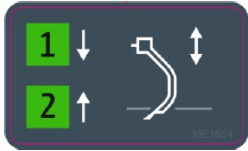

- The working depth of the implement is controlled via the **support wheels** and via the **roller**
- The implement always automatically aligns itself parallel to the ground
- **Single running gear hydraulic cylinder without spacer elements**

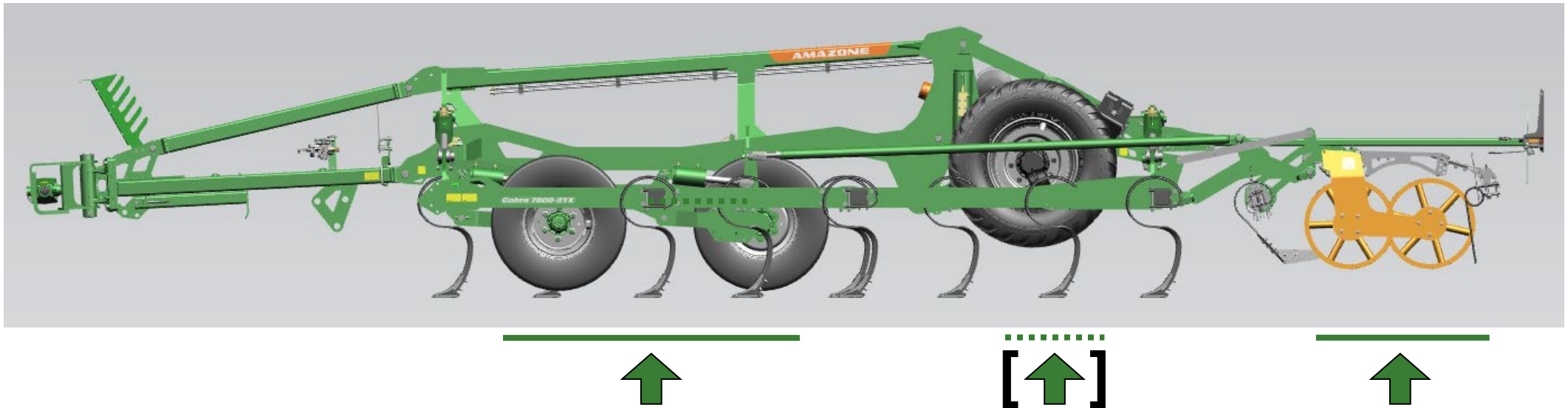

i NOTE

On soils with poor load-bearing capacity, the running gear can provide support by running along.

9. Driving without roller or with double harrow

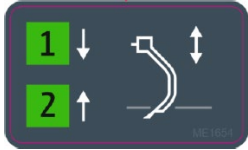

- The working depth of the implement is controlled via the **support wheels** and via the **running gear axle**
- **Double running gear cylinder with spacer elements**
- The rear of the implement must be aligned parallel to the ground using the spacer elements on the running gear hydraulic cylinder (1)



NOTE

- **Basic setting** – 13 x 4 mm and 5 x 10 mm spacer elements
- If necessary, adjust the position of the implement to the soil conditions
- Use more/fewer 4 mm spacer elements accordingly (1)

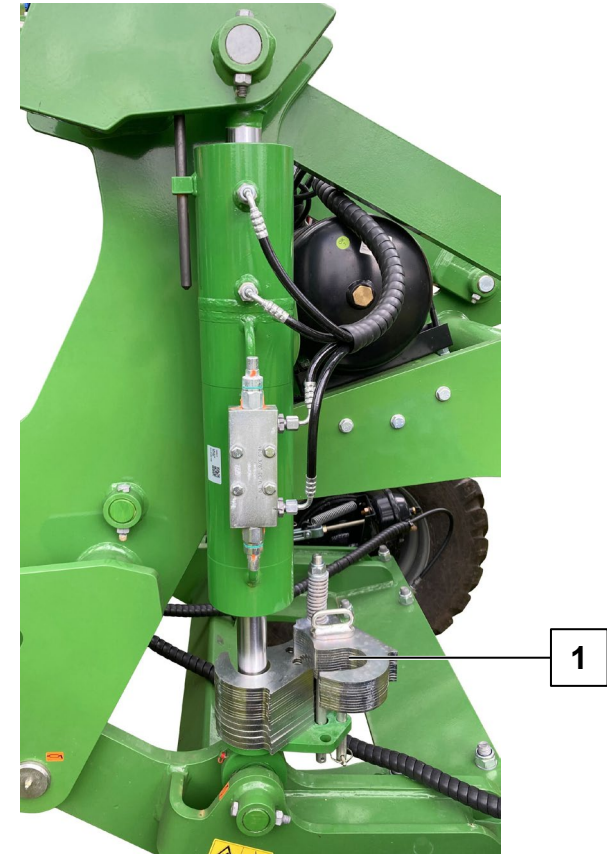
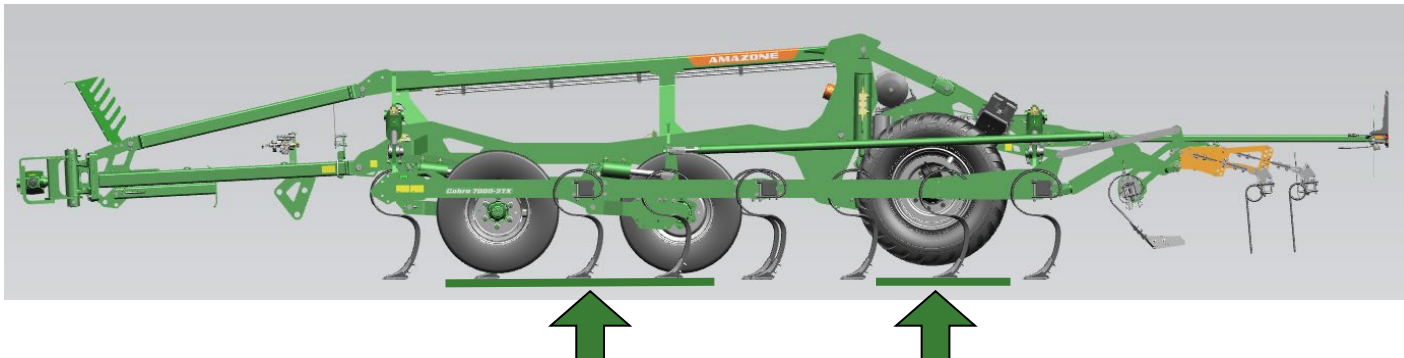

10. Adjusting the levelling unit

1. Set the required working depth (see section 7)
2. Move the implement into **headland position**
3. Adjust the working intensity with the hole pattern (1) – to do so, pull the pin and swivel the levelling unit carrier around its axis
4. For clean connection of the tilled strips, adjust the edge closers
 - Adjust horizontally by pulling out / pushing in the carrier (2)
 - Adjust vertically by loosening the bolted connection of the closer plate and repositioning in the hole pattern of the arm (3)
 - The pitch of the deflector plate can be adjusted via an elongated slot (4)

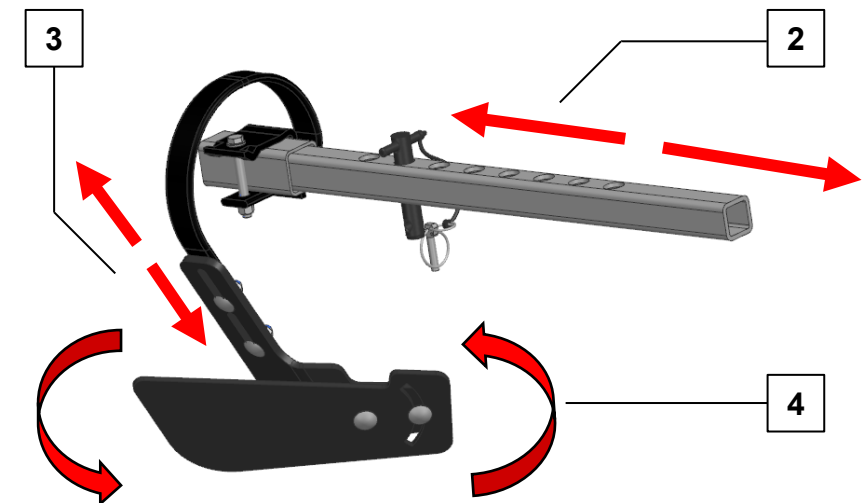
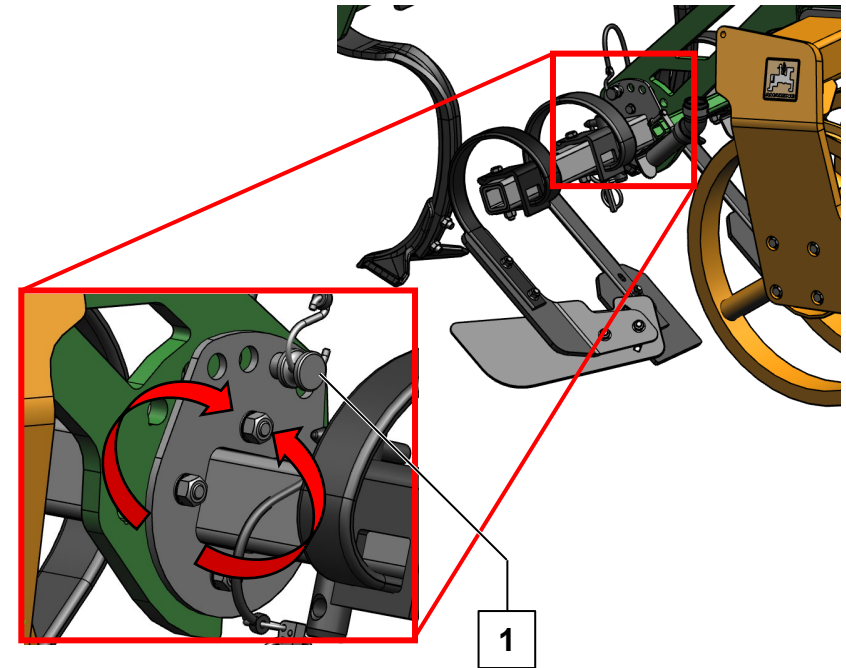

i NOTE

Compensate for wear or work more aggressively by moving the wear plates lower down.

11. Using the crushboard (additional equipment)

1. The working depth can be adjusted during field operation with the beige hydraulic function .

3 ↓ Deeper
 
4 ↑ Shallower

2. Reading of the working intensity as a reference value (!) on the scale – right side section (1).

PLEASE NOTE:

- Calibrate the depth adjustment circuit several times daily.
- Set the minimum working depth /  for approx. 30 s.

Check the work pattern:

- Move the implement into **working position**.
- Drive at working speed (10-16 km/h).
- Check the flow of soil, work and susceptibility to clogging of the crushboard during operation.

NOTE

Compensate for wear or work more aggressively by moving the wear plates lower down (2).

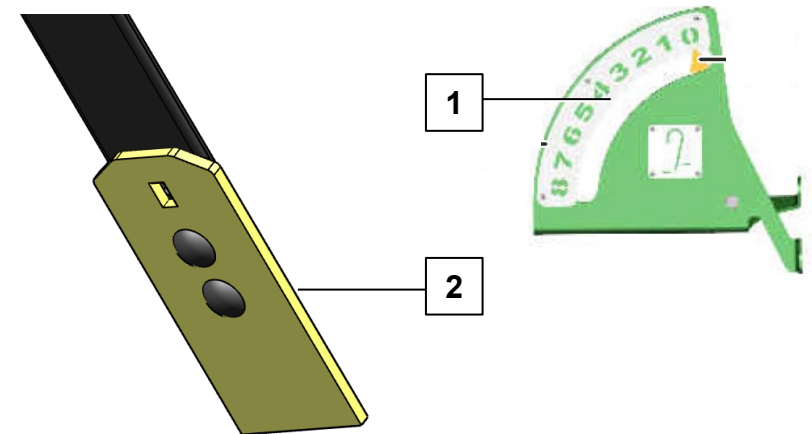
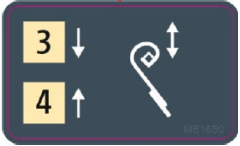

12. Using the cutting roller (additional equipment)

1. Move the implement into **headlands position**.
2. Open the stop tap.
3. Check whether the ball valve for the valve combination is set to "0".
4. Actuate the control unit **3** ↓ . Cutting roller swivels into working position.
5. Switch the control unit **3** ↓ to float position  .
6. Read the pressure on the pressure gauge – it should be between 25 bar and 30 bar.



Adjusting the pressure relief valve

1. Screw the valve insert **(1)** all the way in and unscrew by ¼ turn

Adjusting the pressure reduction valve

1. Move the implement into **headlands position**.
2. Set the ball valve of the valve combination to "1".
3. Set the control unit **3** ↓ to continuous oil flow .
4. Adjust the pressure by screwing in / screwing out the valve insert **(2)**.
5. Read the pressure on the pressure gauge – it should be between 25 bar and 30 bar.

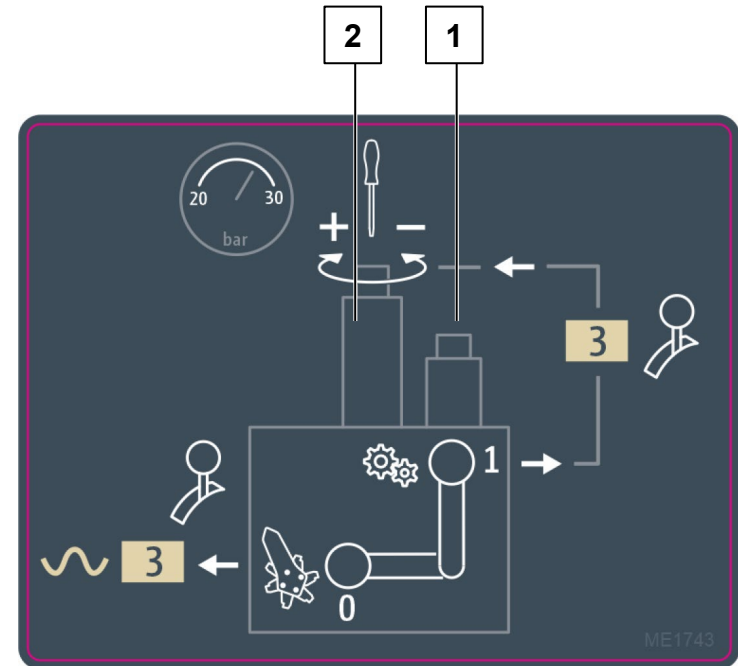
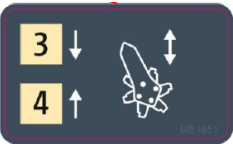
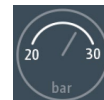

i NOTE

Adjustment of the cutting roller with the procedure described here applies **for implements as of 04/2024!**

13. Using the traction assistance (additional equipment)

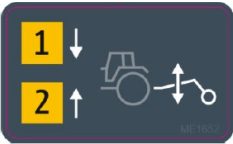

1. Set the traction assistance ball valve to 1 (1)
2. Move the implement into *working position*.

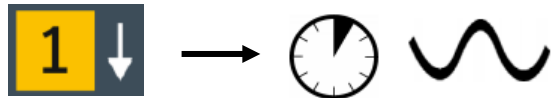

PLEASE NOTE:

- The **traction assistance** must always be **deactivated** during **road transport**.

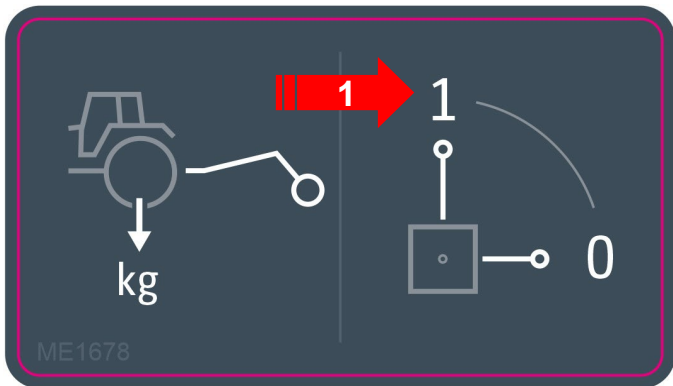

14. Preparing for road transport



1. Move the implement to the *headland position*.



2. Set the implement to the maximum working depth, then switch to float position.

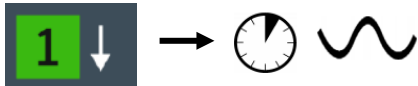

PLEASE NOTE: applies also for implements with mechanical working depth adjustment!

3. Push in the side closers of the levelling unit.

4. Fold the implement.

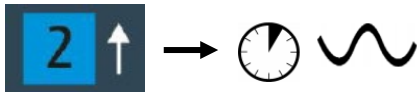

5. Put all of the spacer elements on the drawbar cylinder.

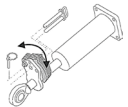

6. Lower the implement until the drawbar cylinder is resting firmly on the spacer elements – pay attention to a transport height of max. 4 m!

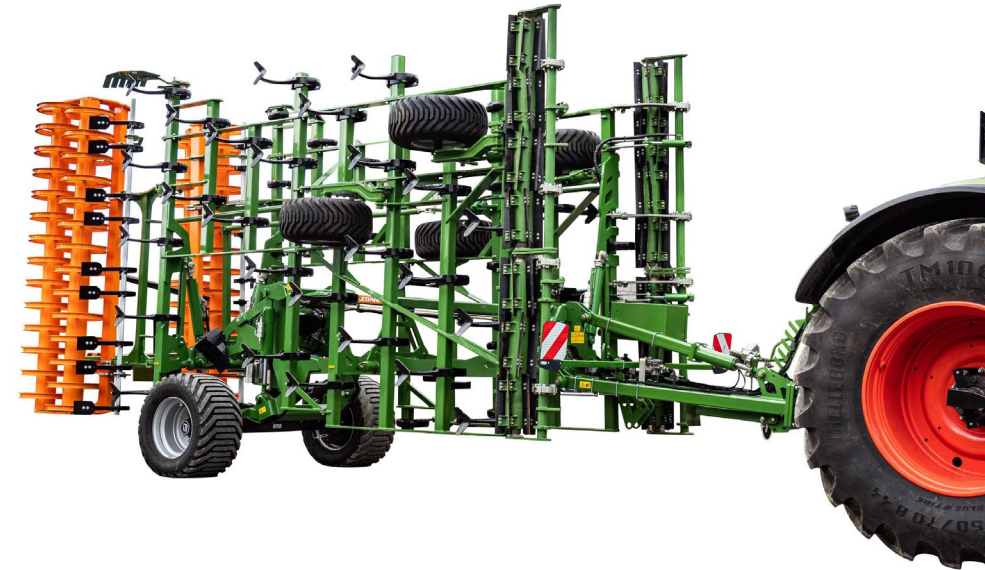
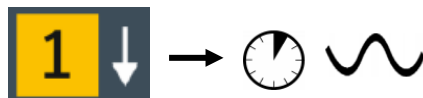

7. Close the stop tap on the drawbar cylinder.

8. Remove loose soil from the working tools and mounted roller / check the lighting and the service brake / install the harrow covering strips (if the harrow is mounted).

PLEASE NOTE:

Points 5 and 7 only for implements with hydraulic drawbar upper belt

15. Preparing for road transport – with crushboard or cutting roller



Cutting roller

1. Move the implement into *headlands position*.

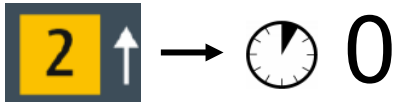

2. Check that the ball valve of the valve combination is set to "0".

2. Lift the cutting roller.



3. Close the stop tap.

4. Switch the beige control unit to float position.



5. Remove loose soil from the roller segments.



Crushboard

1. Move the implement into *headlands position*.



2. Lift the crushboard.



3. Remove loose soil from the tines.

SmartLearning app

The AMAZONE SmartLearning app offers video training courses for the operation of Amazone implements. The video training courses can be downloaded onto your smartphone if necessary, and are therefore available offline. Simply select the desired implement for which you want to watch a video training course.



Info Portal

Our Info Portal provides a wide variety of documents for viewing and downloading at no charge. These can be technical and promotional printed material as an electronic version or also videos, Internet links and contact data. Information can be obtained by mail and subscriptions to new published documents from different categories are available.

www.info.amazone.de/



AMAZONEN WERKE H. Dreyer GmbH & Co. KG

Postfach 51 · D-49202 Hasbergen-Gaste

Tel. +49 (0)5405 501-0 · Fax: +49 (0)5405 501-147

www.amazone.de · www.amazone.at · email: amazone@amazone.de



MG7564