



**AMAZONE**



# Orientation Aid for the Start of the Season UX01 CP+

# Table of Contents

1. General information
2. Start screen of the implement software / TwinTerminal
3. Work menu of the implement software
4. Preparation for operation
5. Procedure during operation
6. Software settings
7. Preparations on the implement - Task Controller

# 1. General information

- Use of this document requires that the **operating manuals** for the implement and the software have been **read** and **understood**. The corresponding documents are shown on the left side.
- For this reason, it is **necessary** to take additional information from the operating manual. The **operating manual** must **always be available** when performing the orientation aid for the start of the season with the UX 01.
- The **Orientation Aid for the Start of the Season - UX 01 CP+** document serves as a guideline for the user to check the implement for the new season and to put it back into operation. This document is based on software version **NW242-F** and is also only valid for this version.



## 2. Start screen of the implement software / TwinTerminal

- The Main menu is divided into the Field menu (1) and the Settings menu (2).
- The menus can be switched by clicking on one of the marked buttons.
- From the Field menu, you can switch to the submenus Work, Documentation, Filling, Cleaning and Agitation. Moreover, it is also possible to enter the desired application rate in l/ha here.
- From the Setting menu, you can switch to the submenus Implement, Profile and Info.

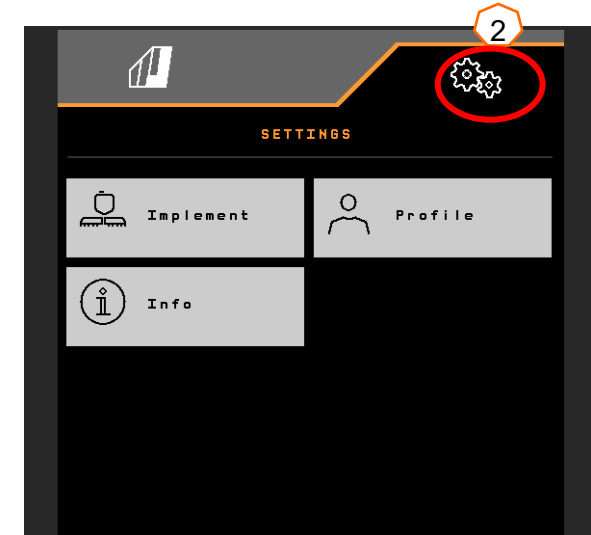

- The Main menu of the TwinTerminal is divided into the Work menu (3) and the Special functions menu (4).
- The menus can be switched by clicking on one of the marked buttons.
- From the Work menu, it is possible to activate the functions Start / Stop hydraulic pump and start filling with saved filling profile, and by selecting a tank, to switch to the submenu for the respective tank.
- From the Special functions menu, it is possible to switch to the following submenus: select filling profile, select filling options, cleaning/winter storage, and set agitator.

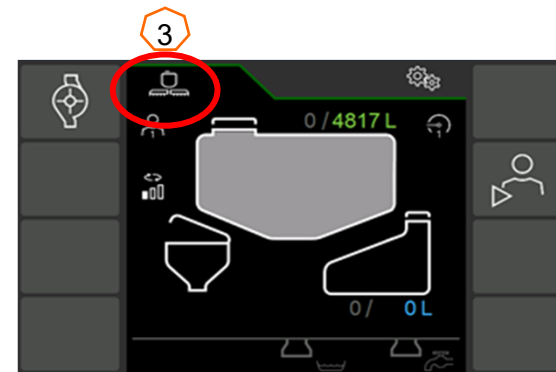

### 3. Work menu of the implement software

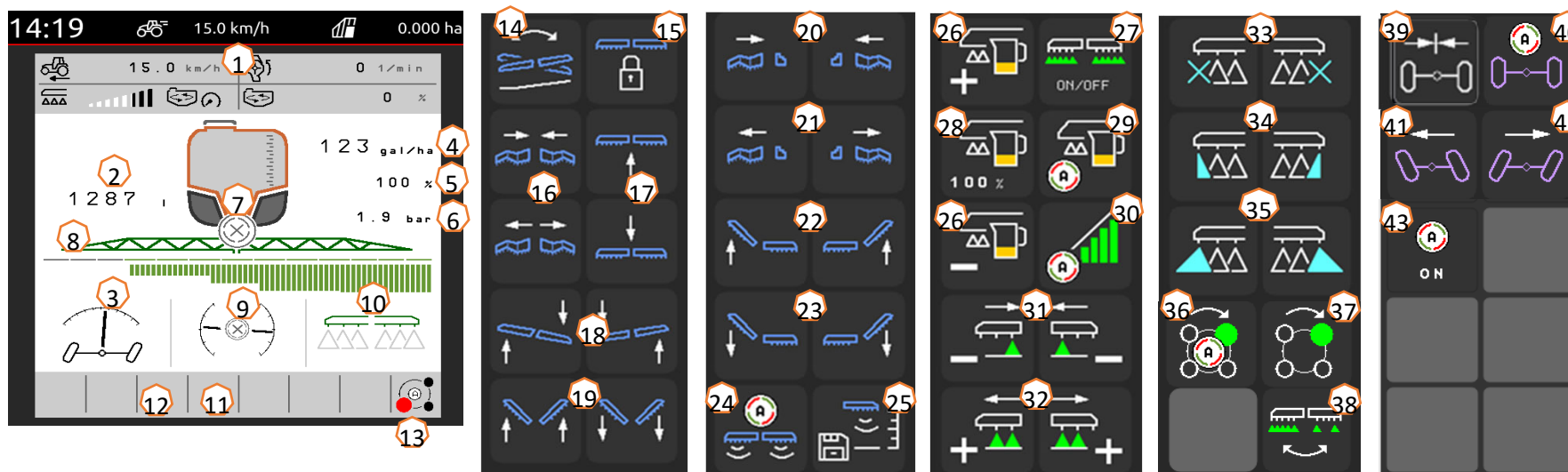

- (1) Multi-function display, freely configurable
- (2) Display of the total fill level
- (3) AutoTrail status \*
- (4) Application rate from the spray liquid tank
- (5) Percent value of the application rate
- (6) Spray pressure
- (7) Section Control status
- (8) Part-width section / nozzle status
- (9) Boom / boom strain status (ContourControl)
- (10) Edge nozzle status \*
- (11) Boom illumination status \*
- (12) Pump status \*
- (13) AmaSelect nozzle body status \*
- (14) Mirror tilt adjustment
- (15) Lock/unlock boom
- (16) Fold/unfold boom on both sides
- (17) Boom lifting / lowering
- (18) Tilt boom to right/left
- (19) Angle boom down/up on both sides \*
- (20) Fold boom on one side on the left/right
- (21) Unfold boom on one side on the left/right

- (22) Tilt boom up on one side on the left / right \*
- (23) Tilt boom down on one side on the left / right \*
- (24) Switch automatic boom guidance on/off \*
- (25) Save spraying height
- (26) Increase/reduce application rate
- (27) Switch spraying on/off
- (28) Reset application rate percent value to 100 %
- (29) Switch automatic rate control on/off
- (30) Switch on Section Control
- (31) Switch part-width sections off
- (32) Switch on the part-width sections
- (33) Switch end nozzles off/on \*
- (34) Switch boundary nozzles off / on \*
- (35) Switch extra nozzles off / on \*
- (36) AmaSelect automatic or manual nozzle selection \*
- (37) Manually select AmaSelect nozzles \*
- (38) Select band spraying or area spraying (AmaSelect Row) \*
- (39) Move AutoTrail to centre position \*
- (40) AutoTrail automatic / manual mode \*
- (41) AutoTrail manual steering to the left \*
- (42) AutoTrail manual steering to the right \*
- (43) Switch automatic functions on, freely configurable

**\*Softkeys depend on the equipment**

## 4. Preparation for operation

### Required tractor equipment

Version	Tractor engine power
UX 4201	Starting at 85 kW (115 HP)
UX 5201	Starting at 95 kW (130 HP)
UX 6201	Starting at 110 kW (150 HP)

- **Tractor pump capacity:**

Profi boom folding	25 l/min
AutoTrail stub axle steering	+ 10 l/min
ContourControl	+ 10 l/min
Flushing water pump	+ 35 l/min
Hydraulic spray pump drive	+ 50 l/min

- **Connections, depending on the implement equipment:**

- 1x pressure-free return flow T, max. 5 bar
- 1x pressure line P, max. 210 bar
- 1x load sensing control line (optional)
- 1x DA jack

- **Coupling the implement:**

Couple the implement with the towing device of the tractor. Take the hydraulic hoses, universal joint shaft, supply line for the lighting, brake lines as well as the ISOBUS plug from the parking positions (1) and couple to the tractor. If a yaw rate sensor is used on the implement side, it is mandatory that it is connected to the tractor.

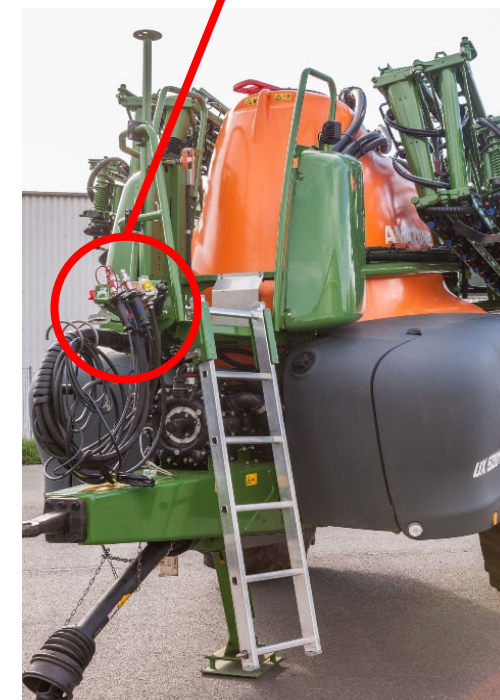
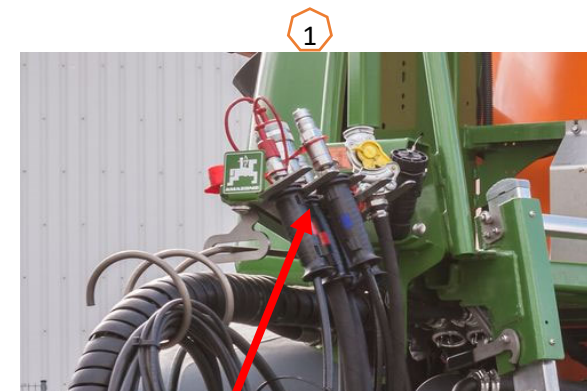

## 5. Procedure during operation

### Filling

#### Filling without a filling profile

- (1) Select the Spray liquid tank menu and/or the Flushing water tank menu on the TwinTerminal.
- (2) Enter the respective target fill level.
- (3) Select "Suction via suction hose" or "Pressure filling".

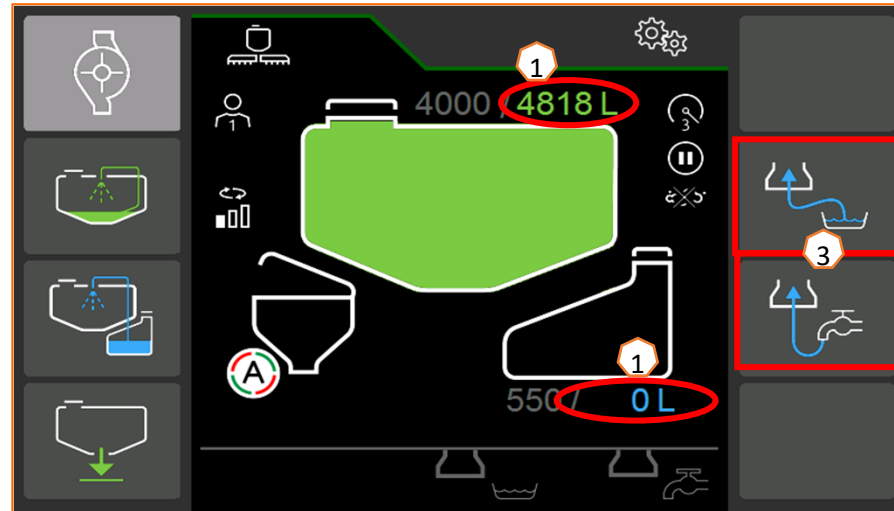

#### Suction filling / pressure filling of the spray liquid tank with a filling profile

Select filling with a previously saved filling profile. A filling profile can be created under the **Setting menu > Profile > Filling profile (4)**.

Press "Start filling profile" **(5)** to activate the filling profile. The filling starts when the induction bowl is folded down.

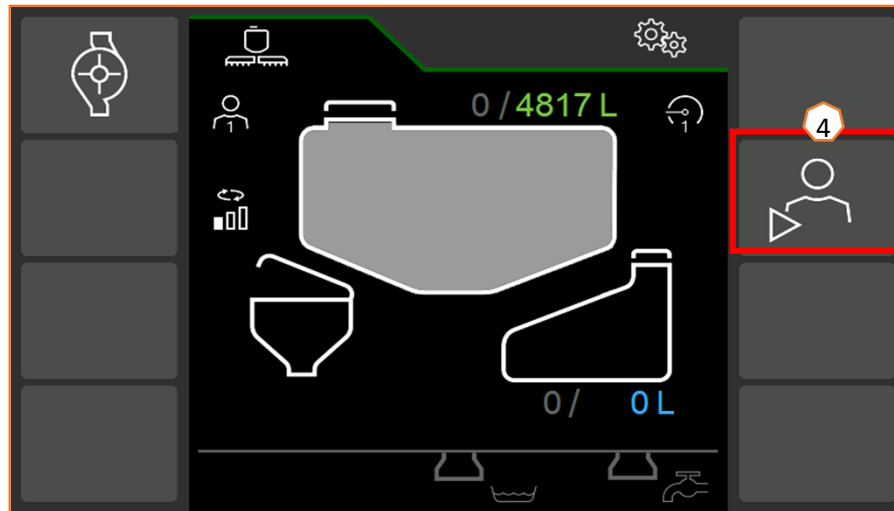

## 5. Procedure during operation

### Induction bowl

The induction bowl can be supplied via:

- the suction connection
- the pressure connection (optional) with water **(1)**.

The following functions can be switched on at the induction bowl:

1. Spray pistol for cleaning the induction bowl **(2)**
2. Mixing nozzle for flushing in powders or pellets **(3)**
3. Canister cleaning **(4)**
4. Ring line to dissolve and flush in crop protection agents **(5)**
5. Induction bowl suction **(6)**

### Supply via the filling:

1. Start a filling of the spray liquid tank and fold down the induction bowl
2. Select a supply for the induction bowl (filling profile or filling **(7)**). If necessary, activate the taps on the induction bowl **(2-5)**
3. To suction the induction bowl empty, set the injector switch tap to "Suction from induction bowl" at the desired position 0-100 % **(6)**

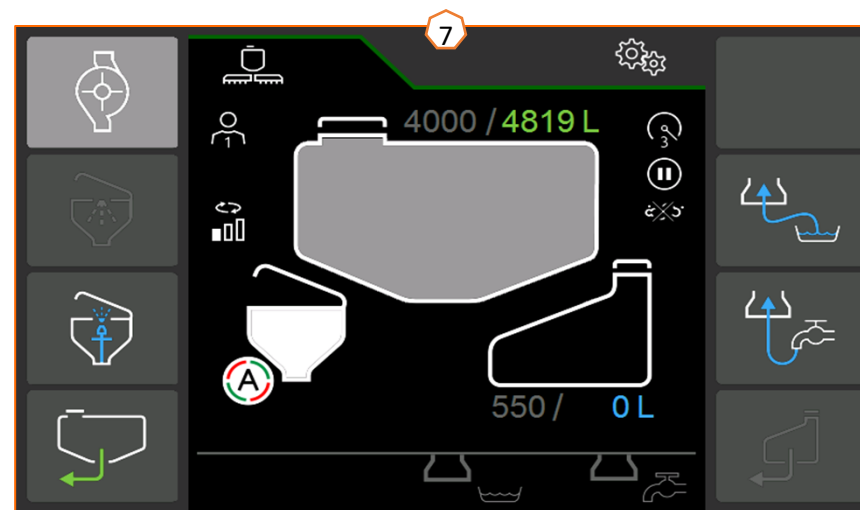
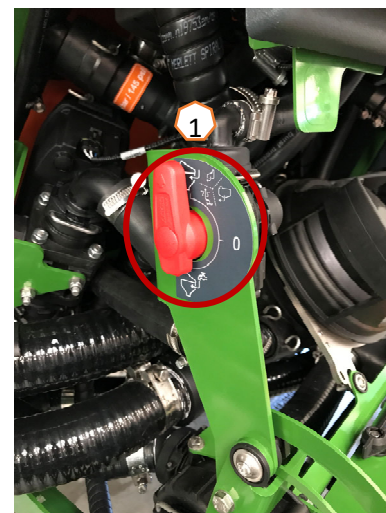



# 5. Procedure during operation

## Agitation

The current agitation level will be shown on the start screen of the TwinTerminal. **(1)**

### Automatic agitator control depending on the fill level:

With the Comfort Package, the desired agitation level can be set on the TwinTerminal **(2)** (Special functions menu>Agitation) or on the control terminal **(3)** (Field menu>Agitation).

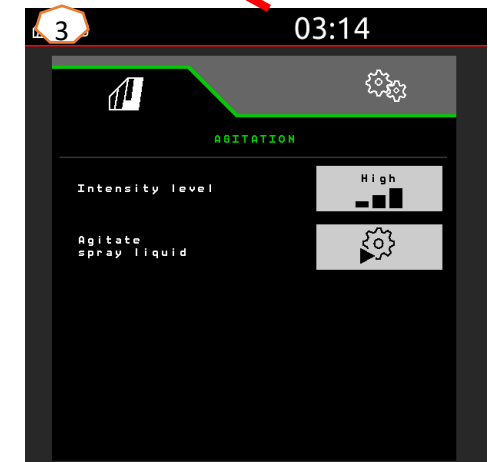
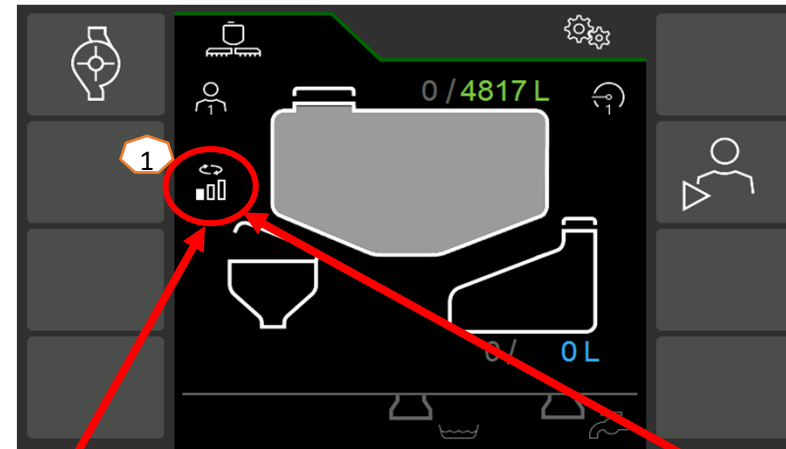

# 5. Procedure during operation

## Put the implement into working position

In the boom kinematics function group, you will find all of the softkeys for moving the boom into working position.

- (1) Lift the boom.
- (2) Unfold the boom to the desired working width.
- (3) When the boom is completely unfolded, the boom can be unlocked.
- (4) Move the boom to the desired spraying height.
- (5) Save the spraying height. \*
- (6) Switch on the automatic boom guidance. The boom must be completely unfolded and unlocked! \*

(7) Switch AutoTrail to automatic mode. \*\*

\* Only with the optional DistanceControl or ContourControl boom guidance

\*\* Optional

## Spraying

1. Per default, the automatic rate control is activated (11). Information on the application are shown on the right of the spray liquid tank (8).
2. Switch on the main part-width section switch (10).
3. Switch on Section Control (12). To be able to activate this function, the following conditions must be met:
  - Section Control of the terminal (Task Controller) activated
  - Implement error free
  - Booms in working position

Depending on the setting, the softkey (12) may not be visible in the Implement menu, but may rather appear in the GPS view. You can find more information about the settings for Section Control in the operating manual for the implement software and the terminal.

4. You can see the status of Section Control based on the symbol (9):

- Grey X: Section Control is not active on the implement and on the terminal
- Symbol flashing in colour: Section Control is active on the terminal, but not on the implement
- Symbol not flashing in colour: Section Control is active on the implement and on the terminal

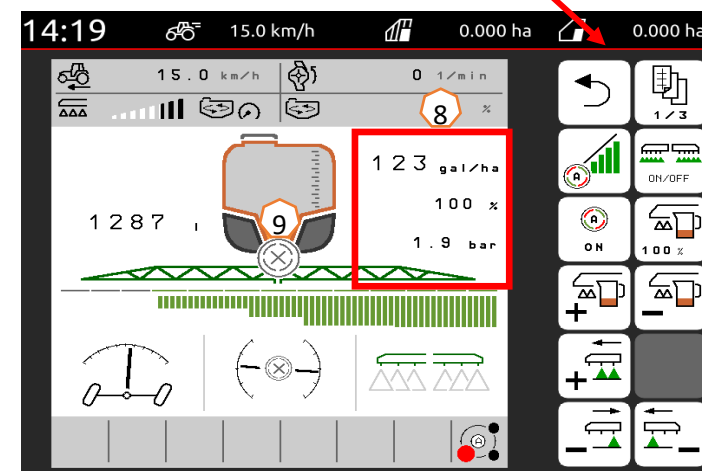
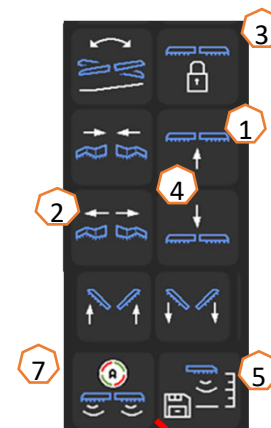

# 5. Procedure during operation

## Cleaning

### Cleaning program:

Various cleaning programs are available in the Cleaning menu.

- (1) Intensive cleaning is suitable before a critical agent change.
- (2) Quick cleaning is suitable for daily cleaning of the sprayer.
- (3) It is recommended to flush the boom before interrupting work. Select whether the spray liquid should be sprayed out or routed back to the tank. After successful flushing, you must first switch off the pump drive and then exit the "Flush boom" menu.
- (4) During the cleaning program, switch the edge nozzles on and off, if necessary.
- (5) For better cleaning results, the spray pressure can be increased manually if necessary when spraying out. For this purpose, deactivate the automatic rate control function and increase the pressure.

**Cleaning the filter and winterising:** through the Special functions menu, you can reach the "Cleaning and winterising" menu item.

- (6) Cleaning the pressure filter when the tank is filled
- (7) Cleaning the suction filter when tank is full
- (8) Residual emptying
- (9) Winterising

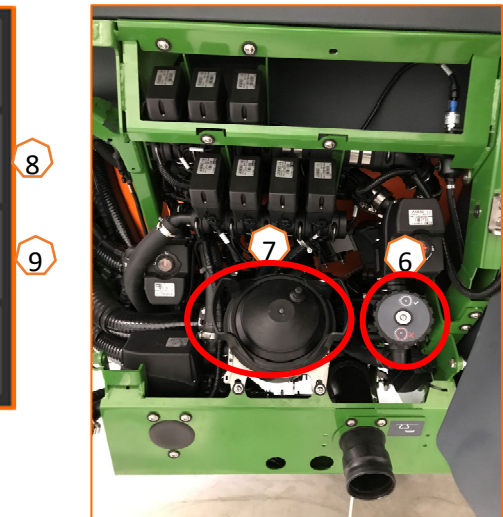
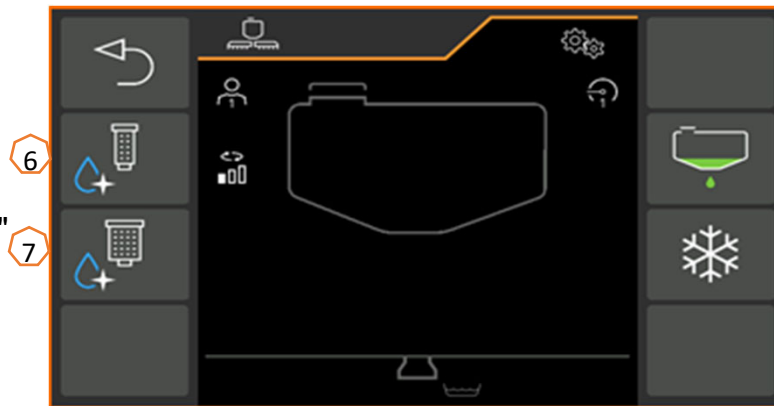
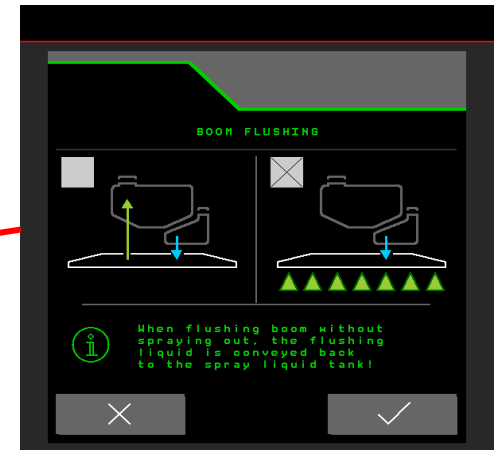
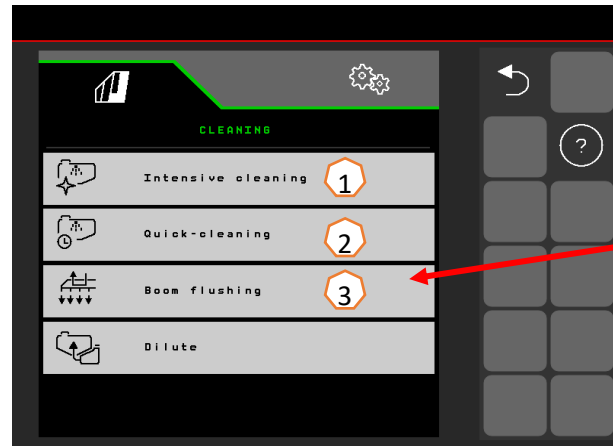

## 6. Software settings

- **(1) Configuring the part-width sections:** Settings menu > Profile > Part-width section control. Here, each part-width section can be configured.
- **(2) Headland pressure:** Setting menu > Profile > Rate control. Here, the desired headland pressure can be set.
- **(3) Start-up ramp:** Setting menu > Profile > Rate control. Here, the "start-up ramp" can be configured. After switching on the sprayer, an increased quantity will be metered for the entered start-up time until the entered start-up speed is reached.
- **(4) Configuring the working height and headland height:** Setting menu > Profile > Boom behaviour. The working height can be set in cm and the headland height in steps: off, low, medium, high, and maximum.

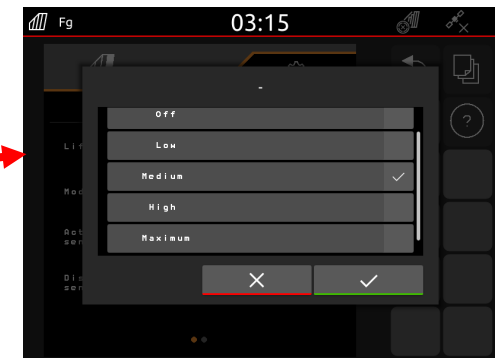
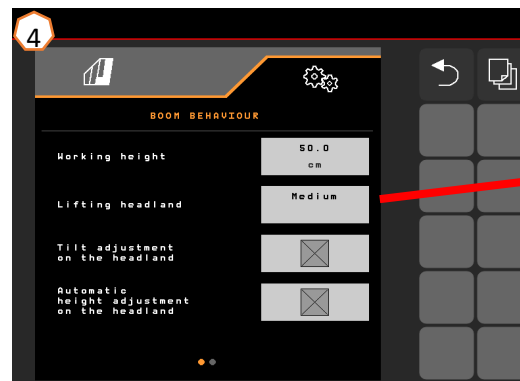
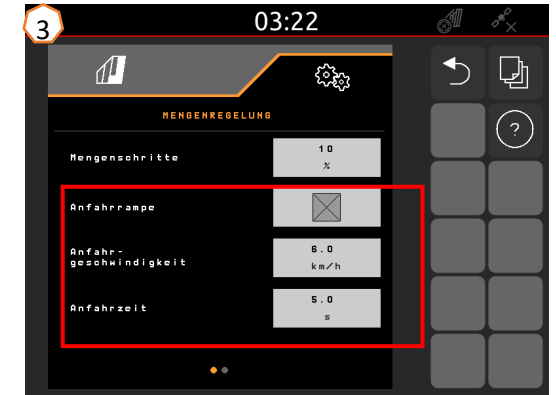
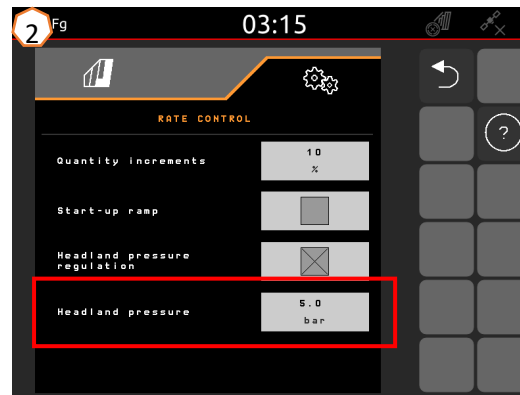
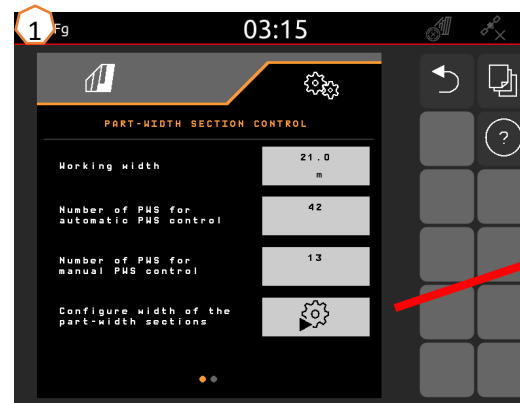

## 6. Software settings

### AmaSelect / CurveControl

- (1) In the **Settings>Profile>AmaSelect>Nozzle body** menu, the assignment of the standard nozzle body must be entered.
- (2) For each existing nozzle, the nozzle size, the pressure range, and the working height is entered. The pressure range must be individually set for automatic switching between the nozzles or nozzle combinations. The set the switching behaviour, the nozzle combination to be used must first be considered. Then the right sequence for the nozzle sizes must be observed.
- (3) In the **Settings>Profile>AmaSelect>Automatic functions** menu, the nozzle combination must then be selected.

### CurveControl

- (4) The CurveControl special equipment must be configured in the **Settings>Profile>AmaSelect>Automatic functions** menu. A choice can be made between three metering functions:
  - Under-metering
  - Normal metering
  - Over-metering

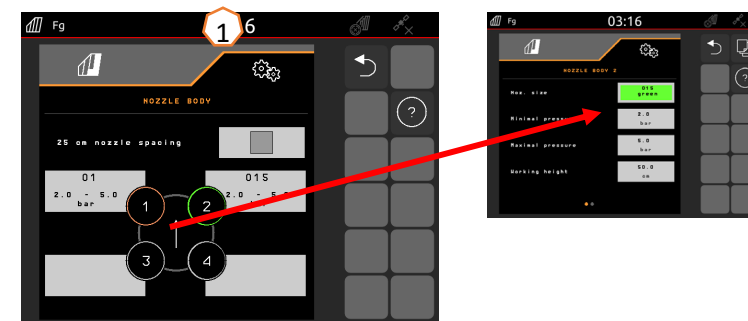

Nozzle combination	Condition
1+2	Nozzle 1 < Nozzle 2
3+4	Nozzle 4 < Nozzle 3
3+4+2	Nozzle 4 < Nozzle 3 < Nozzle 2

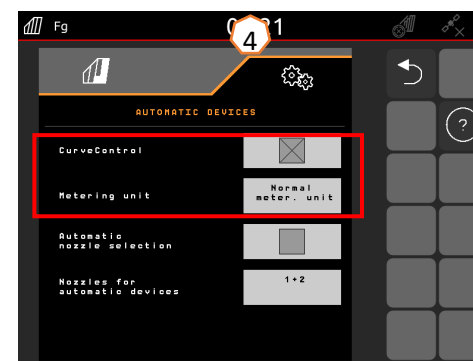
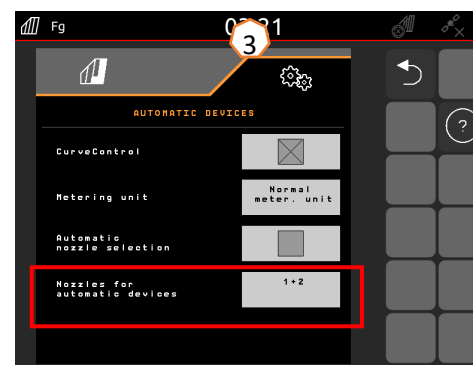

## 6. Software settings

### AmaSelect Row

AmaSelect Row can be configured in the **Settings/Profile/AmaSelect/AmaSelect Row** menu.

- (1) The nozzle assignment must be configured in the **Settings/Profile/AmaSelect/Nozzle bodies** menu. In addition, the nozzle for band spraying must be selected. For 50 cm row spacing: without 25 cm nozzle expansion, any nozzle can be selected, with the 25 cm nozzle expansion, nozzles 3 or 4 must be selected. For 75 cm row spacing, the 25 cm nozzle expansion must be installed. Nozzles 1 and 2 must be selected.
- (2) Selection of the row spacing: 50 cm or 75 cm (only with 25 cm displacement set). When 75 cm row spacing is selected, a selection can be made between treatment on the row (on the plant) or treatment between the rows (nozzles over the plants remain closed). Moreover, the nozzles in the tramline can be deactivated here.
- (3) On the following pages, you can configure:
  - Entry of the theoretical spraying height
  - Entry of the nozzle angle, depending on the utilised nozzle
  - This is used to calculate the theoretical band width.

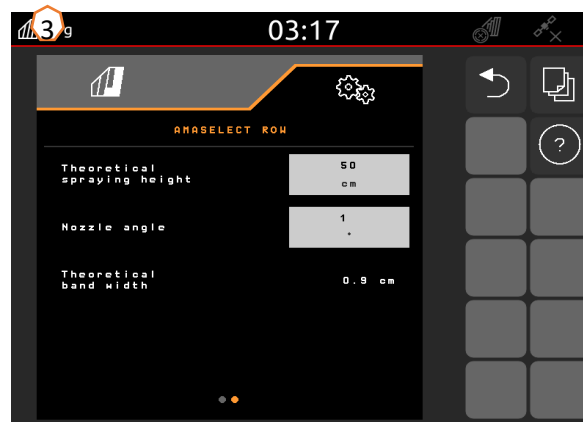
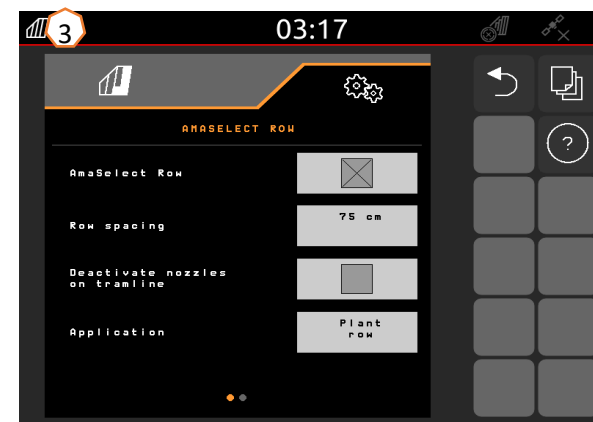
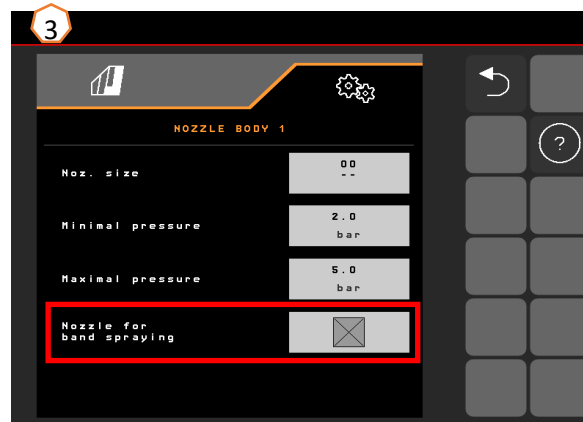

## 6. Software settings

### Steering

- In the **Settings>Profile>Steering menu**, the behaviour of the steering system can be adjusted.
- **(1)** Distance from the tractor's rear axle to the coupling point: The value must be measured and set depending on the tractor.
- **(2)** Steering point delay: with the steering point delay, the moment for driving into the curve can be adjusted. This value or effect is best detected while steering. The behaviour should be checked and adjusted when driving in a 90° curve at the usual forward speed. Ridge planting **(5)** must be deactivated. The higher the value, the later the implement is steered.
- **(3)** Track correction dimension: when the steering point delay **(2)** is correct, the track correction dimension must be set. The track correction dimension can be directly measured on the track. This value can be best observed from the crest to approx. the beginning of the last third of the curve. **PLEASE NOTE!** In doing so, the steering axle may not move all the way to the stop. Otherwise, the track correction dimension cannot be directly measured. The higher the value, the further the sprayer steers outwards (provided that the steering angle has not yet been reached).
- **(4)** Type of slope counter-steering: manual or automatic. On side slopes, the steering system is manually or automatically overridden to correct the tracking of the sprayer.
- **(5)** Ridge planting: for row crops, an increase of the steering angle can be set so that the implement is steered in a larger curve. Ridge curve amplification: the ridge curve amplification parameter describes the amplification of the over-steering. The higher the value, the more the axle is deflected.

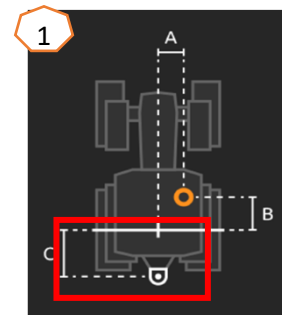

2

A correctly adjusted implement does not "jerk" when steering into the curve and precisely follows the rear wheel track!

1. If the sprayer is steered too late, the steering point delay should be reduced.
2. If the sprayer is steered too early, the steering point delay should be increased.

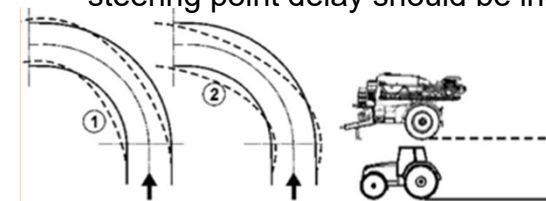

3

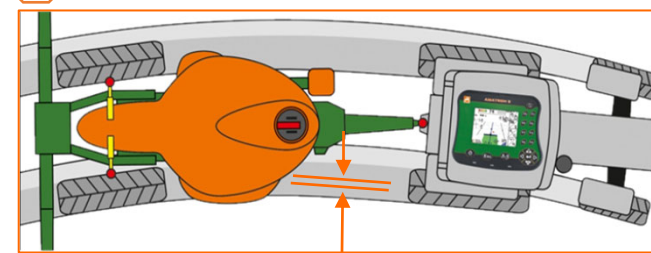

## 6. Software settings

### ContourControl / DistanceControl

- In the **Settings/Profile/Boom behaviour menu**, the following entries are possible:
  - **(1) Working height:** if the automatic boom guidance is activated, the boom (nozzles) will be regulated at this height when spraying.
  - **(2) Lifting the boom at the headlands:** off, low (50 cm), medium (100 cm), high (150 cm) or maximum.
  - **(3) Mode** (only with Flex-folding 2, Profi-folding 2 or ContourControl): tilting or angling
  - **(4) Distance sensors** can be deactivated with ContourControl if necessary. With DistanceControl, this is achieved by unplugging the sensors. This can be necessary, for example, with a reduced working width, if a sensor is looking onto a tramline or in case of failure of one of the sensors.

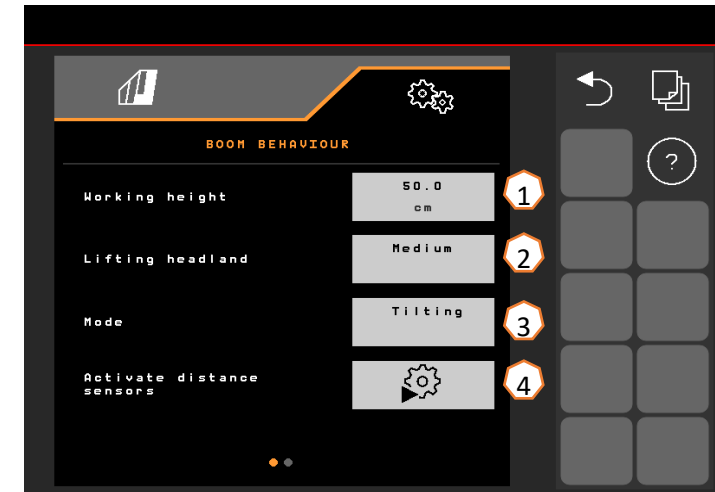

Tilt mode

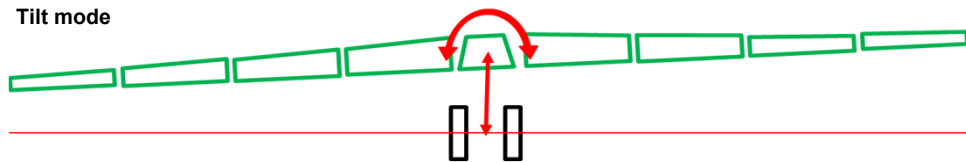

Angle-up mode

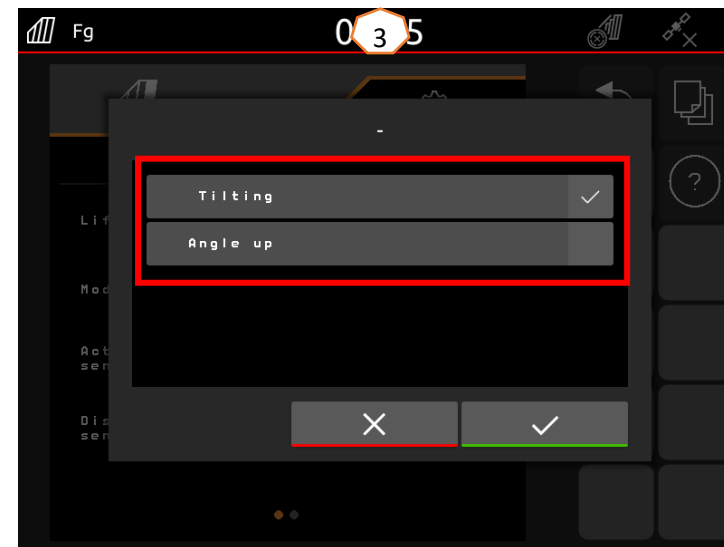
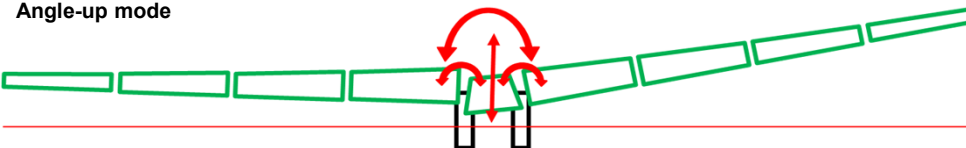



## 7. Preparations on the implement - Task Controller

- **Terminal:** the functions of the Task Controller are controlled via the terminal. The terminal must be prepared accordingly. You can find more information in the operating manual for the respective terminal.
- **(1) Task Controller: Setting menu > Profile > ISOBUS.** Under the Documentation point, there is the choice between "Implement internal" and "Task Controller".
- **(2.3) Application maps / jobs:** the "TC" icon in the Work menu and Field menu indicates that the implement is receiving the target application rates from the Task Controller (application map or job).

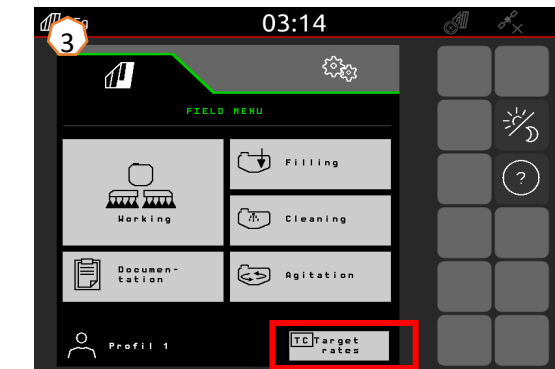
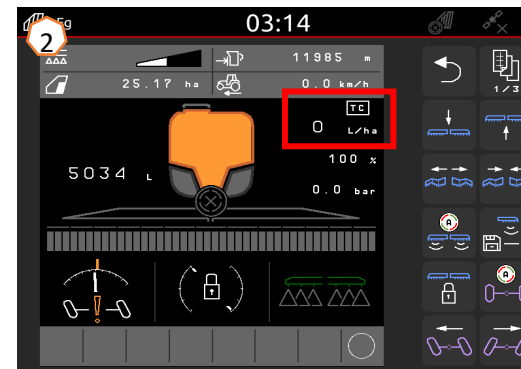
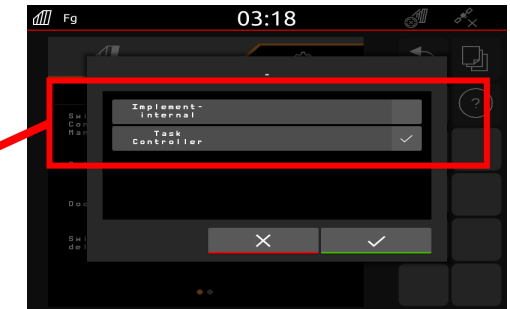

## SmartLearning app

The AMAZONE SmartLearning app offers video training courses for the operation of Amazone implements. The video training courses can be downloaded onto your smartphone if necessary, and are therefore available offline. Simply select the desired implement for which you want to watch a video training course.



## Info Portal

Our Info Portal provides a wide variety of documents for viewing and downloading at no charge. These can be technical and promotional printed material as an electronic version or also videos, Internet links and contact data. Information can be obtained by mail and subscriptions to new published documents from different categories are available.

[www.info.amazone.de/](http://www.info.amazone.de/)



**AMAZONEN-WERKE H. DREYER SE & Co.KG**

Postfach 51 · D-49202 Hasbergen-Gaste

Tel. +49 (0)5405 501-0 · Fax: +49 (0)5405 501-147

[www.amazone.de](http://www.amazone.de) · [www.amazone.at](http://www.amazone.at) · email: [amazone@amazone.de](mailto:amazone@amazone.de)



MG7158